



Operator & Installation Manual

WATER METERS

<i>WM600</i>	<i>ML-132580</i>
<i>WM600C</i>	<i>ML-132580</i>

Model Number: _____

Serial Number: _____

Date of Installation: _____

TABLE OF CONTENTS

GENERAL.....	3
INSTALLATION	4
Unpacking.....	4
Location	4
Wall Mounting	4
Installation Codes and Standards.....	5
Electrical Connections	5
Water Supply	7
Drain Connections	7
Plumbing Connections.....	8
Assembly	10
Setting Water Pressure.....	10
OPERATION	11
Environmental Conditions.....	11
Controls	11
Before First Use.....	13
Using the WM600/WM600C Water Meter	14
Using the Temperature Probe.....	15
Flush Time	16
Shutdown.....	16
CLEANING	17
MAINTENANCE	18
Service and Parts Information	18
Calibration Check	18
Operating Parameter Setup.....	22
TROUBLESHOOTING	24

INSTALLATION, OPERATION AND CARE OF BAXTER MODEL WM600 & WM600C WATER METER

SAVE THESE INSTRUCTIONS

GENERAL

The WM600 & WM600C Water Meter is a microcomputer-controlled water delivery system that enables you to accurately control the water requirements for your baking needs. Through the proper control of water temperature and volume, the water meter will help you gain uniform baking results and maximum productivity.

Baxter Water Meters are produced with quality workmanship and material. Proper installation, usage and maintenance of your water meter will result in many years of satisfactory performance.

It is suggested that you thoroughly read this entire manual and carefully follow all of the instructions provided.

INSTALLATION

The water meter requires separate hot and cold supply lines. Each line should have a manual shutoff valve (not supplied) at the water meter for servicing and shutdown. Before installing, verify that the electrical service agrees with the specifications on the data plate located on the left panel of the water meter. If the supply and equipment requirements do not agree, do not proceed with the installation. Contact your local authorized service office immediately.

UNPACKING

This water meter was inspected before leaving the factory. The transportation company assumes full responsibility for safe delivery upon acceptance of the shipment. Immediately after unpacking, check for possible shipping damage. If the water meter is found to be damaged, save the packaging material and contact the carrier within 15 days of delivery.

LOCATION

Before finalizing location, make sure that consideration has been given for water supply, draining, electrical outlets and service clearances.

WALL MOUNTING

The water meter has a detachable base for wall mounting. It is secured by a machine screw located on the bottom panel.

1. With the water meter lying flat, control face up, remove the machine screw and angle holddown.
2. Slide the water meter forward and set aside.
3. Position the base on the wall and level left-to-right using a carpenter's level.
4. Mark the position and hole location.
5. Mount the base to the wall using the appropriate mounting fasteners.
6. Slide the water meter, with the control panel facing up, downward onto the base. Make sure the horizontal groove on the back of the water meter is lined up with the top edge of the base.
7. Secure water meter to the base with the machine screw and angle holddown.
8. Check to make sure the water meter is level.

INSTALLATION CODES AND STANDARDS

The water meter must be installed in accordance with:

In the United States of America:

1. State and local codes.
2. National Electrical Code, ANSI/NFPA-70 (latest edition). Copies may be obtained from The National Fire Protection Association, Batterymarch Park, Quincy, MA 02169.

In Canada:

1. Local codes.
2. Canadian Electric Code, CSA C22.1 (latest edition). Copies may be obtained from The Canadian Standard Association, 178 Rexdale Blvd., Etobicoke, Ontario, Canada M9W 1R3. (*electric equipment*)

In Europe:

1. Local codes.

ELECTRICAL CONNECTIONS

⚠ WARNING Electrical and grounding connections must comply with the applicable portions of the national electrical code and/or other local electrical codes.

⚠ WARNING Appliances equipped with a flexible electric supply cord are provided with a three-prong grounding plug. This plug must be connected into a properly grounded three-prong receptacle. If the receptacle is not the proper grounding type, contact an electrician. Do not remove the grounding prong from this plug.

Model	Electrical Option		
	US	Europe	Auxiliary Relay Rating
	WM600	WM600C	
Volts	120	230/250	120/240
Hertz	60	50/60	Single Phase
Amp	0.5	1.4/1.3	7 Max.

Electrical data is located on the left panel as you face the water meter. Route the power cord safely out of the way of other equipment, personnel and moisture.

If the equipment is used in a manner not specified by the manufacturer, the protection provided by the equipment may be impaired.

Units with 120VAC Power Supply

- Replace any UL listed fast-acting 0.5A/250VAC fuse inside the water meter if fuse is blown.

Units with 230VAC/250VAC Power Supply

- For 230VAC/250VAC operation, replace any UL listed fast-acting 3A/600V fuse inside the junction box if fuse is blown.

Input power line and branch circuit protection will be provided and wired by customer. Refer to Fig. 1 for 240V junction box wiring diagram.

NOTE: It is recommended that a switch or circuit breaker (marked as the connecting device) is located near the equipment and within easy reach of the operator.

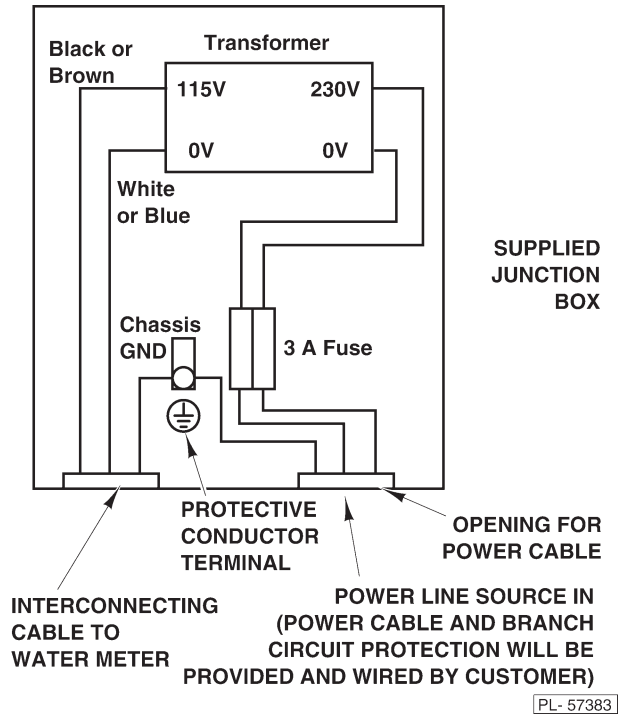

Fig. 1

Water Chiller Option

If water chiller is pump-driven, connect the chiller to the water meter as described in the steps below.

Connection to the water chiller circuit should be done by a qualified electrician or service technician. The auxiliary switch is located in the top-mounted junction box.

⚠ WARNING Disconnect the electrical power to the machine and follow lockout / tagout procedures.

1. Verify that the water chiller circuit does not exceed the auxiliary relay rating.
2. Remove the junction box cover screws, cover and gasket.
3. Connect water chiller and meter per Fig. 2.
4. Install the junction box gasket and cover. Secure with the previously removed junction box screws.
5. Connect power to the meter. While test is flowing, verify that the water chiller pump motor is running in the proper direction.

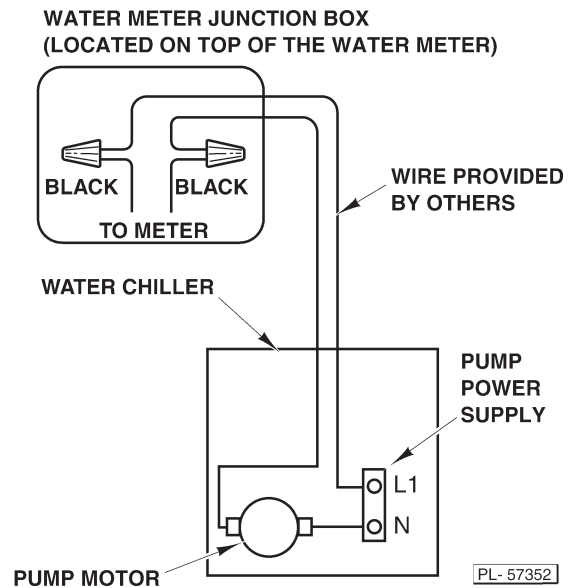

Fig. 2

WATER SUPPLY

The water meter requires separate hot and cold supply lines. A manual shutoff valve (not supplied) should be installed on each supply line at the water meter to accommodate servicing and shutdown.

- HOT WATER INLET TEMPERATURE: 140°F (60°C) recommended.
- HOT AND COLD WATER FLOWING PRESSURE: 30 psi (207 kPa) minimum.
- WATER HARDNESS: 4 to 6 grains per gallon (0.7 to 1.0 grains per liter) is recommended.

DRAIN CONNECTIONS (FIG. 3)

The water meter should be located near a sink for the bypass line to drain into while test flowing or when water is adjusting to a set temperature.

For water meters equipped with a water chiller and with a water reservoir, a bypass return line should be connected back to the water chiller reservoir.

WATER METER AND HAND SINK SETUP

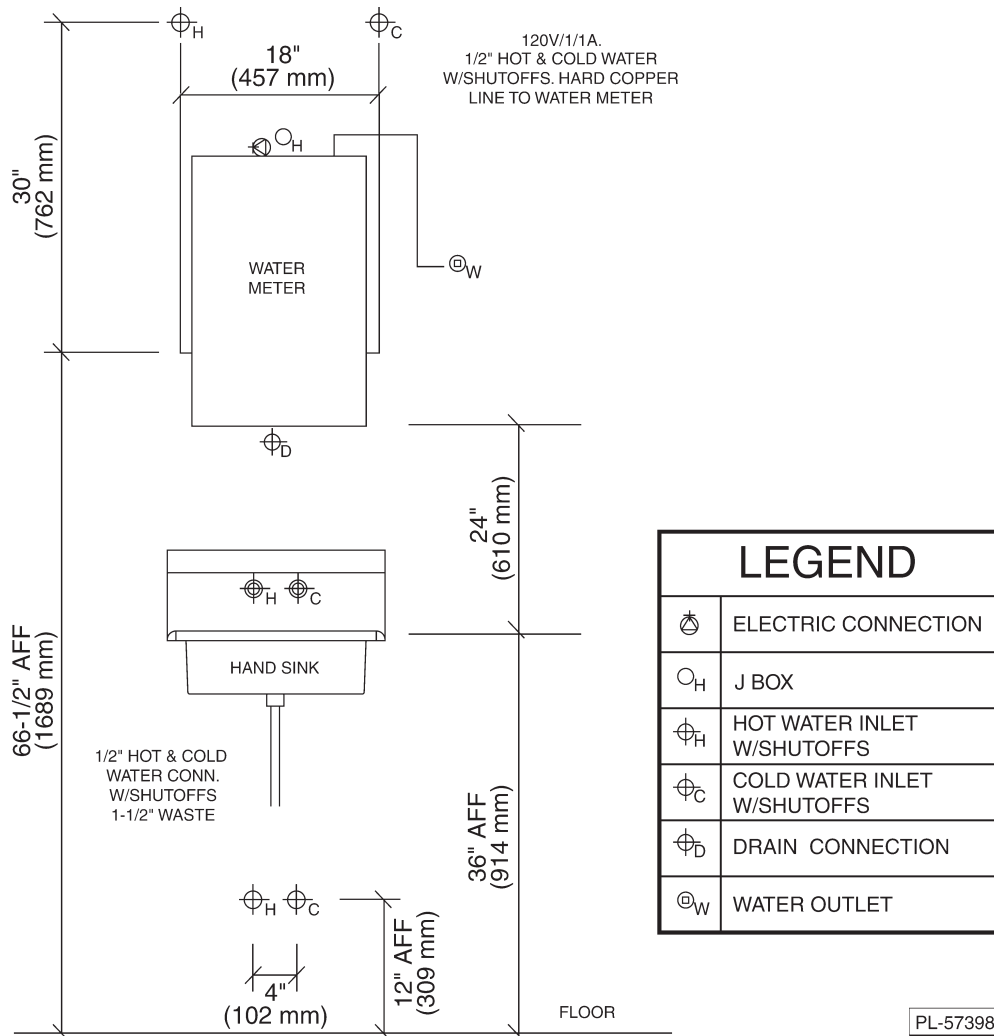

NOTE: The hot and cold water supply lines can vary in location.

Fig. 3

PLUMBING CONNECTIONS

Water and waste piping and connections shall comply with the International Plumbing Code 2003, International Code Council (ICC), or to the Uniform Plumbing Code 2003, International Association of Plumbing and Mechanical Officials (IAPMO).

⚠ WARNING Plumbing connections must comply with applicable sanitary, safety and plumbing codes and provide adequate backflow protection to comply with applicable federal, state and local codes.

Connection to the water supply should be done by a qualified plumber or service technician.

Make sure the water lines are thoroughly flushed out *before* connecting to the water meter. This flushout is necessary to remove all foreign matter, such as chips (resulting from cutting or threading of pipes), pipe joint compound from the lines or, if soldered fittings are used, bits of solder or cuttings from the tubing. Debris, if not removed, may lodge in the valves and render them inoperative.

Manual valves or solenoid valves damaged by foreign matter, and any expenses resulting from this damage, may not be covered under warranty.

Water Chiller Option

1. Connect the water meter cold water supply tubing to the water chiller pump outlet tubing (Fig. 4).
2. Connect the bypass line (supplied) from the water chiller tank to the test flow bypass port on the bottom of the water meter (Fig. 4). Use the bypass line hose fittings (supplied).
3. If not provided, drill a 1 1/32" (26.2 mm) hole through the lid of the water chiller tank, and install the bypass line hose fitting and nut (supplied).

WATER METER WITH OPTIONAL WATER CHILLER AND PLUMBING CONNECTIONS

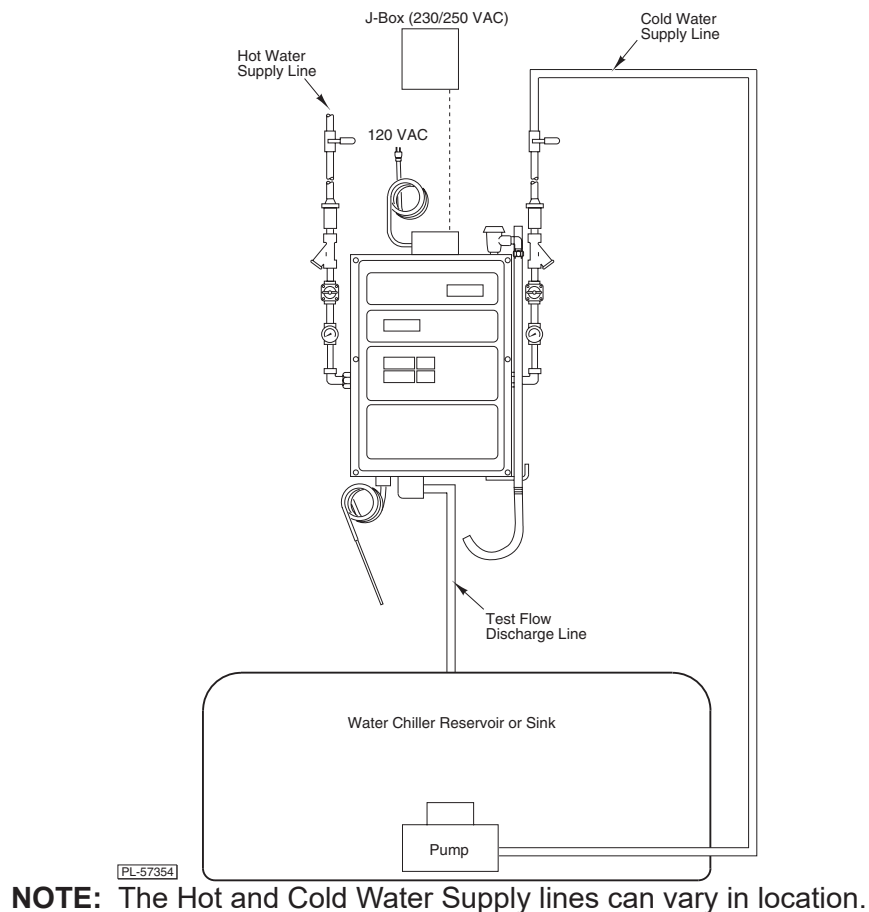

NOTE: The Hot and Cold Water Supply lines can vary in location.

Fig. 4

WATER METER WITH PLUMBING CONNECTIONS

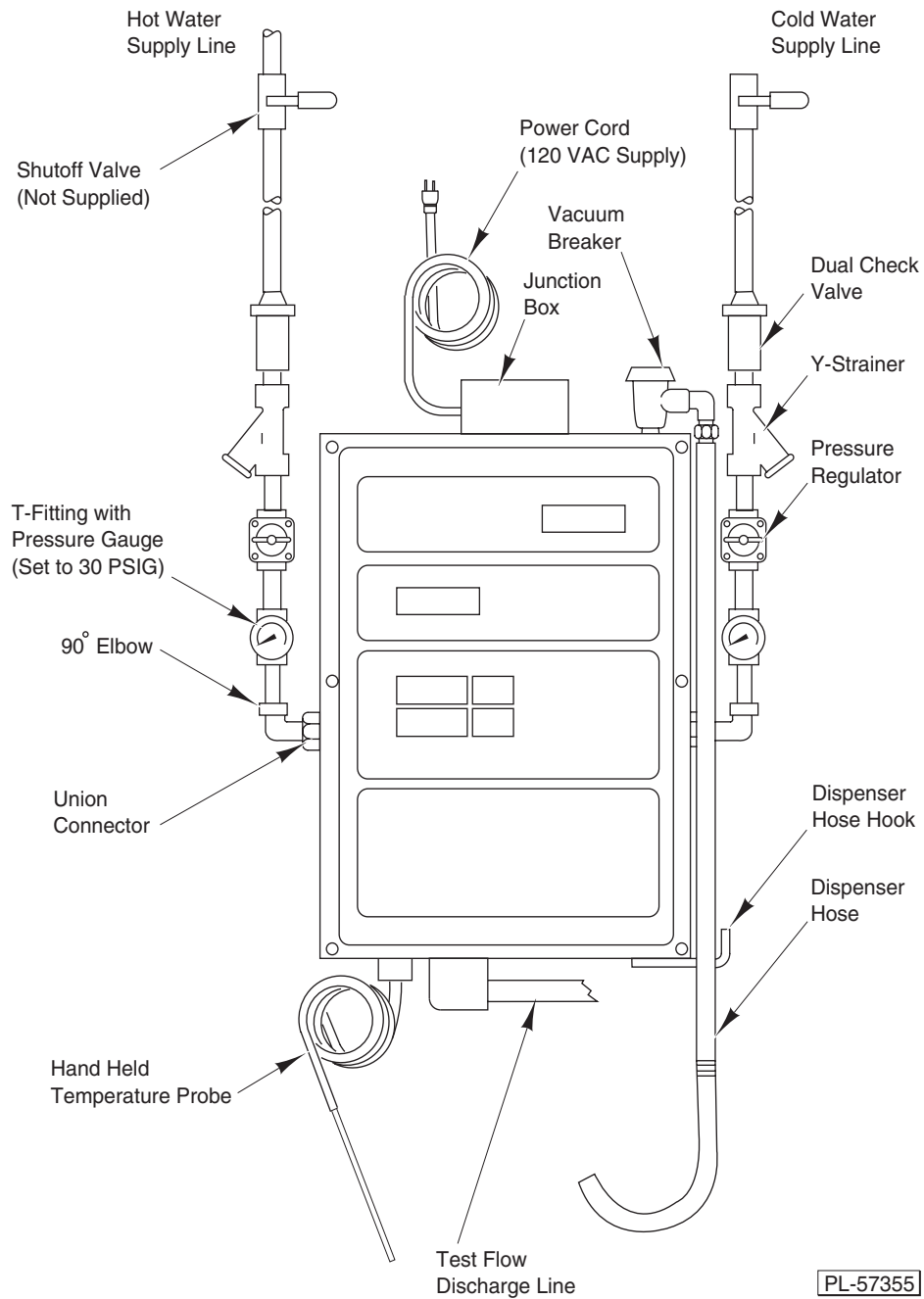

NOTE: The Hot and Cold Water Supply lines can vary in location.

Fig. 5

ASSEMBLY

The water meter is supplied with external fittings/components that must be assembled before the water supply is connected.

Qty.	FITTING/COMPONENTS	Qty.	FITTING/COMPONENTS
2	Pressure Regulator	2	Dual Check Valve
2	90 Degree Elbow	1	Vacuum Breaker
1	Dispenser Hose	2	T-Fitting With Pressure Gauge
2	Y-Strainer	1	Hand Held Temperature Probe
1	20" Bypass Line Hose and Fittings (For water chiller option only. See Fig. 4 under Plumbing Connections.)		

- Assemble the fittings to the water meter as shown in Fig. 5. Use teflon tape or pipe joint compound when assembling.
- The union connection on the water meter has a flat doughnut gasket. Make sure the gasket is in place before connecting any fittings.
- Plug the hand held temperature probe into the end of the flexible cable attached to the bottom panel of the meter.

SETTING WATER PRESSURE

For the water meter to operate properly, the water pressure should be set at 30 psi (207 kPa) on each regulator while it is operating at 125°F (52°C). See Operation on the following pages for a description of the control panel.

1. Press CHANGE UNITS to select English or Metric units. (If the CHANGE UNITS key is locked, see Locking and Unlocking the Change Units.)
2. Press SET TEMP and enter 125°F (52°C) on the numeric key pad. The water temperature value is displayed in the WATER TEMPERATURE window.
3. Hook the dispensing hose over the rim of a sink or drain.
4. Press SET AMOUNT and enter 20 lbs 00 oz.
5. Press START. The water begins dispensing from the bypass line. The actual water temperature of the flowing water is displayed in the WATER TEMPERATURE window.
6. Allow the flowing water temperature to reach 125°F (52°C) and switch over to delivery.
7. Adjust both hot and cold water regulators until the pressure gauges read 30 psi (207 kPa).

OPERATION

ENVIRONMENTAL CONDITIONS

- Indoor use at altitudes up to 6,500 ft. (2,000 m).
- Main supply voltage fluctuations up to +/-10% of nominal voltage.
- Installation category III, pollution degree II.
- The normal ambient operating temperature is between 41°F (5°C) and 105°F (40°C). The normal operating water temperature is between 32°F (0°C) and 125°F (52°C).

CONTROLS

Hand Held Temperature Probe

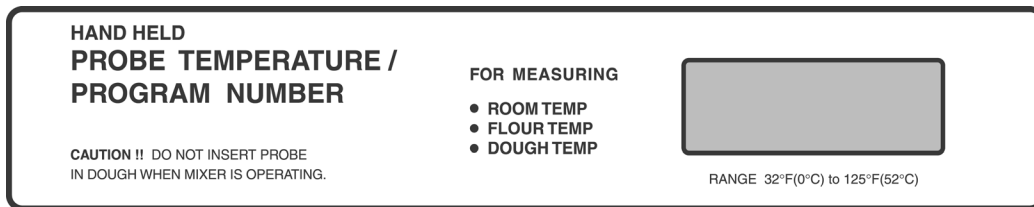

PL-57667

The temperature window displays the temperature recorded by the hand held probe. The probe measures the temperature of the room, dough or flour. The temperature range is 32°F to 125°F (0°C to 52°C).

Water Temperature

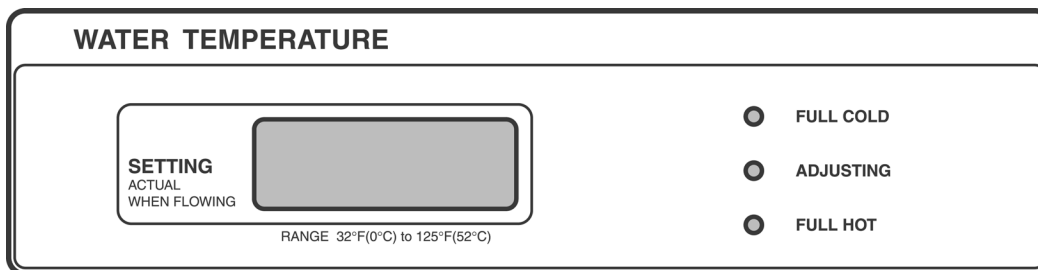

PL-57668

SETTING window - Displays the water temperature as the water meter is dispensing. It also displays the selected water temperature when the meter is idle.

FULL COLD light - Indicates the mixing valve is using cold water only.

ADJUSTING light - Indicates the mixing valve is adjusting the water temperature.

FULL HOT light - Indicates the mixing valve is using hot water only.

Water Amount

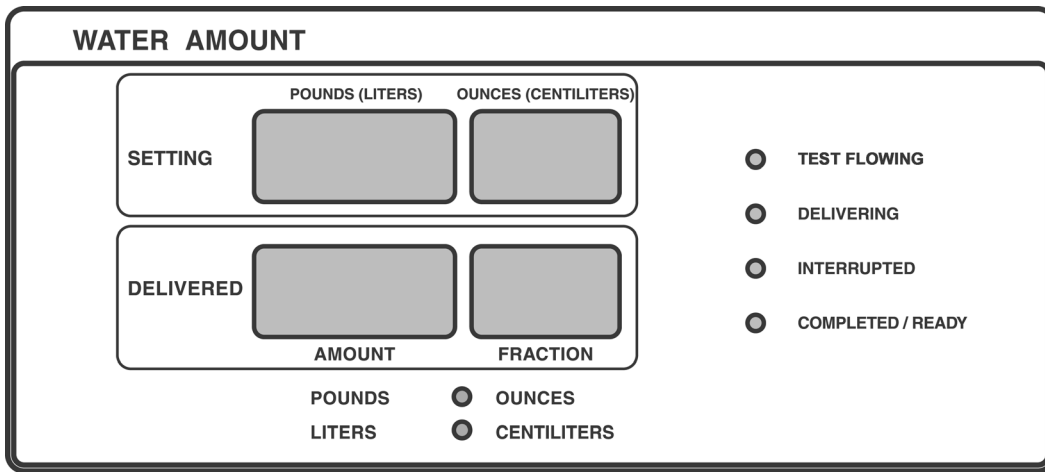

PL-57669

SETTING window - Displays the amount of water to be delivered, in pounds and ounces. Up to five digits may be entered; the last two digits are always for ounces.

Setting ranges are as follows:

Pounds: 0 to 999

Ounces: 0 to 15

Liters: 0 to 461

Centiliters: 0 to 99

DELIVERED window - Displays the amount of water dispensed in pounds and ounces.

TEST FLOWING light - Indicates the meter is dispensing out of the bypass (test flow) line.

DELIVERING light - Indicates the meter is dispensing the entered water amount out of the dispenser hose.

INTERRUPTED light - Indicates the meter has stopped before all of the water amount could be delivered.

COMPLETED/READY light - Indicates the meter has dispensed the entered water amount, and is ready for the next dispensing cycle.

Control Panel

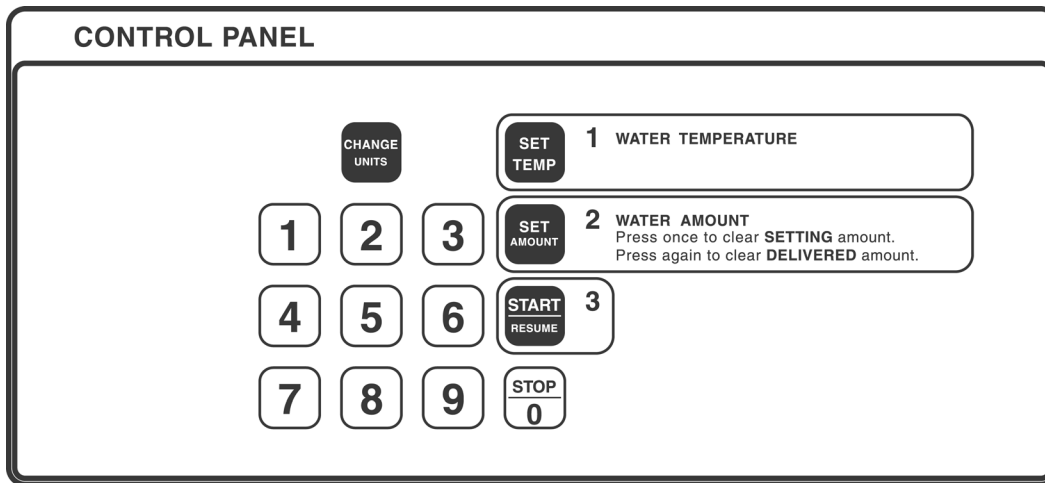

PL-57670

For complete control of the water meter functions, a numeric key pad and the following control keys are provided.

CHANGE UNITS key - Press to change °F to °C and pounds to liters. If **CHANGE UNITS** key is locked, see Locking and Unlocking the Change Units on page 15.

SET TEMP key - Press to enter desired water temperature. Enter the value on the numeric key pad.

SET AMOUNT key - Press to enter the amount of water you would like to dispense. Enter the value on the numeric key pad.

START/RESUME key - Press to dispense the entered water amount. Press to resume dispensing cycle after an interruption.

STOP/0 key - Press to stop dispensing water.

BEFORE FIRST USE

The water meter should be checked for dispensing accuracy before operation begins. See Calibration Check on page 18.

USING THE WM600/WM600C WATER METER

Change Units (English/Metric)

When the Water Meter is first powered up, press CHANGE UNITS to select the English units (Fahrenheit and Pounds) or Metric unit (Celsius and Liters). If the unit of measure DO NOT change, the CHANGE UNITS key is locked. See Locking and Unlocking the Change Units on page 15 to unlock.

1. Press CHANGE UNITS to select Fahrenheit or Celsius.
2. Press CHANGE UNITS to select Pounds/Ounces or Liters/Centiliters.

The Units can be changed individually as follows:

Change Temperature Unit:

1. Press SET TEMP.
2. Press CHANGE UNITS to select Fahrenheit or Celsius.
3. Enter a new temperature setpoint.

Change Amount Units:

1. Press SET AMOUNT.
2. Press CHANGE UNITS to select Pounds or Liters.
3. Enter a new amount setpoint.

NOTE: Units cannot be changed if the Water Meter is flowing water to either the bypass or delivery lines, or is paused in this process. The Water Meter automatically saves the unit change on the power down.

Setting Water Temperature, Water Amount and Dispensing

1. Press SET TEMP.
2. Enter desired temperature on the numeric key pad. The water temperature value is displayed in the WATER TEMPERATURE window.
3. Hook the dispensing hose over the rim of the container to which the water is to be delivered.
4. Press SET AMOUNT.
5. Enter the desired water amount value on the numeric key pad. The entered value is displayed in the WATER AMOUNT SETTING window.

NOTE: The value for ounces must be 15 or less; otherwise, the OUNCES display will blink and no water will dispense.

6. When the water reaches the selected temperature it will automatically switch delivery from the bypass line to the delivery hose.
7. Place the dispensing hose on the hook, located on the side of the water meter.

NOTE: Do not drain the remaining water from the hose.

Operating Hints

- To interrupt the water delivery, press STOP/0.
- To continue dispensing, press START/RESUME.
- To cancel dispensing, press SET AMOUNT.
- The amount of water dispensed is displayed in the WATER AMOUNT DELIVERED window. When the delivery is complete, the display will blink and indicate 0 POUNDS 0 OUNCES.
- If the set temperature is not reached within the preset time allowed (see Flush Time), the meter will flash and beep until a new temperature is set, the amount is changed or the START/RESUME button is pressed. If the START/RESUME button is pressed, the meter will deliver the set amount.
- To get better results, always discard the first water sample when the new temperature is entered or the unit has not been operated longer than 15 minutes.

USING THE TEMPERATURE PROBE

1. Verify that the hand held temperature probe is plugged into the end of the flexible cable attached to the bottom panel of the meter.
2. Place the end of the probe where the temperature needs to be measured. The HAND HELD PROBE TEMPERATURE window will display the temperature reading.

NOTE: The probe can be used to measure the temperature of the room, dough or flour in the range of 32°F (0°C) to 125°F (52°C). The probe must be in place for 30 seconds to get an accurate temperature reading.

Locking and Unlocking the Change Units

The CHANGE UNITS key can be locked to prevent it from being changed. To access Locking and Unlocking the Change Units parameter, follow the steps below:

1. Press SET TEMP.
2. Enter 32 using the numeric keypad.
3. Press SET AMOUNT.
4. Enter 94404 using the numeric keypad. The WATER AMOUNT SETTING window displays 944 lbs 04 oz.
5. Press START/RESUME. The WATER TEMPERATURE SETTING window displays **0** (Units is not locked) or **1** (Units is locked).
6. Enter desired value on the numeric keypad. If no change is desired, proceed to the next step.
7. Press START/RESUME to save the setting.

FLUSH TIME

Water is circulated through the water chiller bypass line to the chiller tank. The flush time setting allows for a certain amount of time for the meter to find the set temperature, within +/- 2°F (1°C). The default flush time is 120 seconds.

Changing Flush Time

The flush time should be set long enough so the desired set temperature can be reached before switching from the bypass line to the dispensing hose.

1. Press SET TEMP.
2. Enter 32 using the numeric keypad.
3. Press SET AMOUNT.
4. Enter 95505 using the numeric keypad. The WATER AMOUNT SETTING window displays 955 lbs 05 oz.
5. Press START/RESUME. The WATER TEMPERATURE SETTING window displays the current flush time in seconds.
6. Enter a new flush time value between 60 and 240 using the numeric key pad.
7. Press START/RESUME to save this setting.

SHUTDOWN

Shutdown procedures should be followed when the water meter is not used for an extended period of time.

1. Close the hot and cold water supply valves.
2. Empty any remaining water from the dispensing hose.
3. Place the dispensing hose on the hook located on the side of the water meter.
4. Unplug the power cord from the electrical outlet.

CLEANING

⚠ WARNING Disconnect the electrical power to the machine and follow lockout / tagout procedures.

- Clean the hand held temperature probe daily with warm, soapy water. Follow with a warm water rinse. Wipe with a soft, dry cloth.
- Clean the stainless steel surfaces with a damp cloth and polish with a soft, dry cloth. To remove discolorations, use a nonabrasive cleaner.
- Clean the control panel with a damp cloth only.
- Do not use any cleaners containing oil or other flammable ingredients.
- Do not spray the water meter with a hose, pressure washer or steam cleaner.

MAINTENANCE

⚠ WARNING Disconnect the electrical power to the machine and follow lockout / tagout procedures.

On an annual basis, have the temperature, water volume and water weight settings calibrated by an authorized service technician.

At regular intervals, check the temperature probe, water volume and weight against a known constant for accuracy (see Calibration Check below).

SERVICE AND PARTS INFORMATION

Contact your local authorized service office.

CALIBRATION CHECK

Before performing calibration check:

- Check to see if the hot/cold water supply pressure is a minimum of 30 psi (207 kPa).
- Check to see if the hot water supply temperature is at least 140°F (60°C).
- For the highest degree of accuracy, calibrate the Water Meter in English units.

Check Delivery Amount (Three Samples Will Need To Be Collected)

NOTE: Wait at least 30 seconds between taking consecutive samples.

1. Set water delivery amount to 6 lbs 4 oz which equals 100 ozs.
2. Hook the dispensing hose over the rim of a sample container.
3. Press START/RESUME to dispense a water sample. Do not drain the remaining water from the dispensing hose between sample collections. If the dispensing hose is dropped or drained, start at step 2 again.

NOTE: The unit will dispense to the overflow tube until the temperature set point is reached.

4. When the dispensing is complete, place the hose on the hook located on the side of the water meter.
5. Weigh the sample on an accurate (digital type preferred) scale and record the results.
6. Repeat steps 2 through 5 to obtain three sample weights.
7. Discard the first sample, use the second and third samples for calculation. Both the second and third samples should be within 1.5 oz (6 lbs 2.5 oz to 6 lbs 5.5 oz) of 100 ozs. If not, then calibrate the delivery.

Calibrating Delivery Amount

1. Remove the cover from the water meter and obtain the “K” value from the Seametrics label attached to the SPX-050 flow sensor.
2. Subtract 30 from the “K” value of the flow sensor and note this number for entry later.
3. Press SET TEMP.
4. Enter 32 using the numeric keypad.
5. Press SET AMOUNT.
6. Enter 93303 using the numeric keypad. The WATER AMOUNT SETTING window displays 933 lbs 03 oz.
7. Press START/RESUME. The WATER TEMPERATURE SETTING window displays the preset “K” calibration value.

NOTE: Default setting is 658 and has a range from 558 to 758.

8. Using the numeric keypad, enter the calculated “K” calibration value obtained in step 2 above.
9. Adjust calibration value using the table (Fig. 6) below using the numeric keypad.

Ounces Measured	105.0	104.0	103.0	102.0	101.0	100.00	99.00	98.00	97.00	96.00	95.00
Adjusted Calibration Value by	-25	-20	-15	-10	-5	0	5	10	15	20	25

Fig. 6

NOTE: If the sample measurements are not within the range of the chart, call your authorized service office.

10. Press START/RESUME to store the new calibration value.
11. After changing number, go to page 18 to Check Delivery Amount.

Changing Time Out For Bypass Flow

1. Press SET TEMP.
2. Enter 32 using the numeric keypad.
3. Press SET AMOUNT.
4. Enter 95505 using the numeric keypad. The WATER AMOUNT SETTING window displays 955 lbs 05 oz.
5. Press START/RESUME. The WATER TEMPERATURE SETTING window displays the current calibration value.
6. Enter a new calibration value between 60 and 240 (1 number is 1 second) using the numeric keypad.
7. Press START/RESUME to store the new calibration value.

NOTE: Determine how long the unit attempts to adjust the water temperature to the water temperature setting before beeping and giving the operator an opportunity to manually start the measured flow even though temperature is not yet at set point. The value ranges between 60 seconds to 240 seconds (1 number is 1 second). The default value is 120.

Calibrating Delivery Temperature (Low and High Temperature Calibration)

Low End Water Calibration 32°F (0°C)

1. Press SET TEMP.
2. Enter 32 using the numeric keypad.
3. Press SET AMOUNT.
4. Enter 96606 using the numeric keypad. The WATER AMOUNT SETTING window displays 966 lbs 06 oz.
5. Press START/RESUME. The WATER TEMPERATURE SETTING window displays the current calibration value.
6. Enter a new calibration value between 0 and 30 (1 number is 0.5°F, so 0 = -7.5°F, 15 = 0°F and 30 = +7.5°F). The default value is 15 (which is 0 degrees of the temperature offset).
7. Press START/RESUME to store the new calibration value.

NOTE: To determine what number is needed here, determine the number of degrees by which the delivery was off and adjust the calibration value up by 2 numbers per degree to decrease the actual temperature delivered or down by 2 numbers per degree to increase the actual temperature delivered. See the example in Fig. 7.

High End Water Calibration 120°F (49°C)

1. Press SET TEMP.
2. Enter 32 using the numeric keypad.
3. Press SET AMOUNT.
4. Enter 96607 using the numeric keypad. The WATER AMOUNT SETTING window displays 966 lbs 07 oz.
5. Press START/RESUME. The WATER TEMPERATURE SETTING window displays the current calibration value.
6. Enter a new calibration value between 0 and 30 (1 number is 0.5°F, so 0 = -7.5°F, 15 = 0°F and 30 = +7.5°F). The default value is 15 (which is 0 degrees of the temperature offset).
7. Press START/RESUME to store the new calibration value.

NOTE: To determine what number is needed here, determine the number of degrees by which the delivery was off and adjust the calibration value up by 2 numbers per degree to decrease the actual temperature delivered or down by 2 numbers per degree to increase the actual temperature delivered. See the example in Fig. 7.

Delivered Water Temperature (F)	Change Number
92.50	0
93.00	1
94.00	3
95.00	5
96.00	7
97.00	9
98.00	11
99.00	13
100.00	15
101.00	17
102.00	19
103.00	21
104.00	23
105.00	25
106.00	27
107.00	29
107.50	30

Fig. 7

Calibrating Hand Held Probe Temperature (Low and High Temperature Calibration)

Low End Probe Calibration 32°F (0°C)

1. Press SET TEMP.
2. Enter 32 using the numeric keypad.
3. Press SET AMOUNT.
4. Enter 97707 using the numeric keypad. The WATER AMOUNT SETTING window displays 977 lbs 07 oz.
5. Press START/RESUME. The WATER TEMPERATURE SETTING window displays the current calibration value.
6. Enter a new calibration value between 0 and 30 (1 number is 0.5°F, so 0 = -7.5°F, 15 = 0°F and 30 = +7.5°F). The default value is 15 (which is 0 degrees of the temperature offset).
7. Press START/RESUME to store the new calibration value.

NOTE: To determine what number is needed here, determine the number of degrees by which the delivery was off and adjust the calibration value up by 2 numbers per degree to decrease the actual temperature delivered or down by 2 numbers per degree to increase the actual temperature delivered. See the example in Fig. 8.

High End Probe Calibration 120°F (49°C)

1. Press SET TEMP.
2. Enter 32 using the numeric keypad.
3. Press SET AMOUNT.
4. Enter 97708 using the numeric keypad. The WATER AMOUNT SETTING window displays 977 lbs 08 oz.
5. Press START/RESUME. The WATER TEMPERATURE SETTING window displays the current calibration value.
6. Enter a new calibration value between 0 and 30 (1 number is 0.5°F, so 0 = -7.5°F, 15 = 0°F and 30 = +7.5°F). The default value is 15 (which is 0 degrees of the temperature offset).
7. Press START/RESUME to store the new calibration value.

NOTE: To determine what number is needed here, determine the number of degrees by which the delivery was off and adjust the calibration value up by 2 numbers per degree to decrease the actual temperature delivered or down by 2 numbers per degree to increase the actual temperature delivered. See the example in Fig. 8.

NOTE: Low end calibration should be performed with ice water if it is possible. High end calibration should be performed as close to 120°F (49°C) if it is possible. Verify the reading with a good thermometer.

Delivered Water Temperature (F)	Change Number
92.50	0
93.00	1
94.00	3
95.00	5
96.00	7
97.00	9
98.00	11
99.00	13
100.00	15
101.00	17
102.00	19
103.00	21
104.00	23
105.00	25
106.00	27
107.00	29
107.50	30

Fig. 8

OPERATING PARAMETER SETUP

The WM600 water parameters can be viewed and customized to fit your specific needs using the parameter setup mode.

Before entering the parameter setup mode, read all the instructions to make sure you are completely clear on what to do. If you need assistance, please call your authorized service office.

Entering Parameter Setup Mode

1. Press SET TEMP.
2. Enter 32 using the numeric keypad.
3. Press SET AMOUNT.
4. Enter the PARAMETER NUMBER using the numeric keypad (for example, 93303 for Sensor PPG, 933 Lbs/L 03 oz/cl will display).
5. Press START/RESUME. The WATER TEMPERATURE SETTING window displays the current parameter value.
6. Enter desired value on the numeric keypad. If no change is desired, proceed to the next step.
7. Press START/RESUME to store the new calibration value.

Parameters Table					
PARAMETER NUMBER	PARAMETER	DESCRIPTION	DEFAULT	RANGE	UNITS
89808	MODE SELECT	STANDARD MODE - 0 (200) - All functions DDI MODE - 1 (201) - Standard mode, but no unit changes.	0	0-201	selection
93303	PULSES/ GALLON	Calibration number (2 ranges) to match actual K factor of sensor. See Maintenance "Calibrating Delivery Amount"	658	144 - 164 558 - 758	PPG
93304	SENSOR SELECT (FOR SERVICE USE ONLY)	Set to "0" for 154 PPG sensor Set to "1" for 658 PPG sensor	1	0 or 1	0=154PPG 1=658PPG
94404	LOCK UNITS	If set to 1, current unit selection cannot be changed. NOTE: CANNOT CHANGE UNITS IN DDI MODE (MODE 1)	FALSE	0 (FALSE) or 1 (TRUE)	selection
95505	TEMP ADJ. TIMEOUT	Maximum allowed time for water temperature to be reached. If time reached after start, delivery may be manually started.	120	60 - 240	seconds
96606	WATER TEMP LOW CALIB.	Used to modify lower point in 2-point calibration. See Maintenance "Low End Water Calibration 32°F (0°C)"	15	0 - 30	offset units 15 = 0 offset
96607	WATER TEMP HIGH CALIB.	Used to modify upper point in 2-point calibration. See Maintenance "High End Water Calibration 120°F (49°C)"	15	0 - 30	offset units 15 = 0 offset
97707	PROBE TEMP LOW CALIB.	Used to modify lower point in 2-point calibration. See Maintenance "Low End Probe Calibration 32°F (0°C)"	15	0 - 30	offset units 15 = 0 offset
97708	PROBE TEMP HIGH CALIB.	Used to modify upper point in 2-point calibration. See Maintenance "High End Probe Calibration 120°F (49°C)"	15	0 - 30	offset units 15 = 0 offset

TROUBLESHOOTING

Symptom	Problem	Corrective Action
Water meter indicator lights and displays are off.	No power.	Plug power in and/or check circuit breakers.
		Check fuse.
Water temperature does not stabilize.	No hot or cold water supplied to meter.	Check that both hot and cold water supply valves are open.
	Pressure is not set to minimum of 30 psi.	Adjust water pressure (see Setting Water Pressure on page 10).
Water does not dispense when START/RESUME key is pressed.	The hot or cold water supply valves are closed.	Open the hot and cold water supply valves.
	Cold water inlet temperature is higher than set temperature or hot water inlet temperature is lower than set temperature.	Set the new temperature above the cold water inlet temperature or below the hot water inlet temperature.
	No water amount has been entered.	Enter a water amount.
	Incorrect water amount has been entered.	Enter pounds and ounces within the correct range. Pounds: 0 to 999 Ounces: 0 to 15
	Bypass flow is time out.	See Changing Time Out For Bypass Flow on page 19.
The dispensed water amount does not match the amount delivered.	The dispensing hose was drained.	Always use the dispensing hook on the meter between dispensing tasks to prevent accidental drainage.
	Low water supply pressure.	Adjust water pressure (see Setting Water Pressure on page 10).
	The meter is out of calibration.	See Calibration Check on page 18.
The temperature of the water delivered does not match the set temperature.	Temperature is out of calibration.	See Calibrating Delivery Temperature on page 20.
	Hot water inlet temperature is less than recommended temperature.	Adjust hot water inlet temperature to minimum of 140°F (60°C).
	First water sample not discarded.	Discard first water sample when the new temperature is entered or unit has not been operated for a while.

If symptom(s) persist, call your local authorized service office.